

AQUAPHOR[®]

water filters

AQUAPHOR WATER SOFTENER

Operation manual



S1000, S1000 P1

Congratulations on your purchase of a high quality filter for softening and deferrization of water Aquaphor.

The Aquaphor water softener filter (hereinafter referred to as the softener) is a high-performance device that removes high concentrations of hardness salts, iron and manganese, ensures long-term operation without replacing the sorbent, and minimizes salt and water consumption during regeneration.

Please read this manual carefully before operating the product and keep it for future reference.

The manufacturer reserves the right to make changes to the design of the softener without reflecting them in the instruction manual. This manual provides installation, operation and maintenance information for the softener models S1000, S1000 P1.

Contents

| | |
|--|-----------|
| Specifications | 3 |
| Source water requirements | 4 |
| Softener delivery set | 4 |
| General softener device | 5 |
| Appearance | 5 |
| Lid removal | 5 |
| Bypass valve | 6 |
| Controller | 6 |
| Control buttons | 6 |
| Controller Screen | 7 |
| Installing a softener | 8 |
| Step-by-step instructions for installing a softener | 9 |
| Controller setup | 12 |
| Quick Setup / Basic Settings | 12 |
| Mode of enhanced washing from iron | 13 |
| Advanced settings | 13 |
| Salt regeneration mode change | 13 |
| Recommendations for effective use softener | 13 |
| Safety regulations | 14 |
| Rules for storage and transportation | 14 |
| Disposal | 14 |
| Terms of Service and Warranties | 14 |
| Troubleshooting | 16 |
| Warranty coupon Aquaphor Softener | 19 |
| Installation information | 19 |

Specifications

| | |
|--|--------------------------------|
| Maximum capacity, g | 2061 |
| Maximum compensated hardness, mg/l | 1712 |
| Maximum concentration of dissolved iron and manganese, mg/l* | 14 |
| Minimum pH | 6 |
| Temperature of water and environment, °C | +5...+38 |
| Water pressure, MPa | 0.14–0.7 |
| Minimum water flow for backwash, l/min** | 7.6 |
| Maximum flow to drain during regeneration, l/min | 9.1 |
| Nominal / maximum flow, l / min | 25 / 38 |
| Pressure loss at flow 22.7 l/min (6 gpm), MPa*** | 0.1 |
| Capacity in HE mode, kg of salt / gram of hardness | 1.1 / 670 |
| Capacity in HC mode, kg of salt / gram of hardness | 3.0 / 1406 |
| Maximum capacity in AU mode, kg of salt / gram of hardness | 5.4 / 1680 |
| Regeneration method | Intelligent, by water meter |
| Power options | 12 VAC; 50/60 Hz; 0.015 kWh |
| Connection ports (NPT) | 1" (MNPT) |
| Minimum drain line diameter, mm (in) | 16 (5/8) |
| Filtration tank size (ID × H), mm | 267 × 584 |
| Height, cm | 79.5 |
| Base, cm | 40.4 × 48.5 |
| Gross weight, kg | 48 |
| Filter medium and its quantity | |
| Superfine monodisperse ion exchange resin, l | 28 |
| Quartzite, kg | 0.8 |
| or KDF85****, l | 0.35 |

* Reducing the concentration of iron to 0.3 mg/l and below, manganese - to 0.1 mg/l and below.

** The flow rate must be checked at the end of the drain line.

*** For the correct selection of the filter, use the operating capacity and pressure drop. Long-term operation at flows higher than those tested (more than 30 l/min) may lead to a decrease in cleaning efficiency.

**** Only for version S1000 P1.

Source water requirements

| Source water requirements | Softener S1000 | Softener S1000 P1 |
|---|-------------------|-------------------|
| Water hardness, mg-eq / l* | no more than 34 | |
| Content of divalent iron, mg/l* | no more than 14 | |
| Content of ferric iron, mg/l | no more than 0.3 | |
| Manganese content, mg/l* | no more than 3 | |
| pH | 6 to 9 | |
| Temperature, °C | from +5 to +38 | |
| Content of oil products, mg/l | no more than 1 | |
| Hydrogen sulfide, mg/l | no more than 0.03 | no more than 1 |
| Permanganate oxidizability, mgO ₂ /l | no more than 5 | |
| Silicon, mg/l | no more than 10 | |

* The total "iron + hardness + manganese", in terms of calcium carbonate, should not exceed the maximum compensated hardness indicated in the "Specifications" table.

ATTENTION! The softener does not purify water from colloidal iron or iron contained in organic complexes.

Softener delivery set

| | | |
|----|--|--------|
| 1. | Complete softener | 1 pc. |
| 2. | Overflow fitting | 1 pc. |
| 3. | Drainage tube D=16 mm (5/8"), L=2.5 m | 1 pc. |
| 4. | Flexible hose 1" by 3/4" (3/4" by 3/4") with o-rings | 2 pcs. |
| 5. | Power supply 12 VAC | 1 pc. |
| 6. | Controller | 1 pc. |
| 7. | Drain pipe 1/2" | 1 pc. |

For Owner's Reference

| | |
|-------------------------|--|
| Aquaphor Softener Model | |
| Serial # | |
| Date of Installation: | |
| Hardness: | |
| Iron: | |
| pH: | |
| Water Pressure: | |
| Water Temperature: | |

General softener device

Appearance

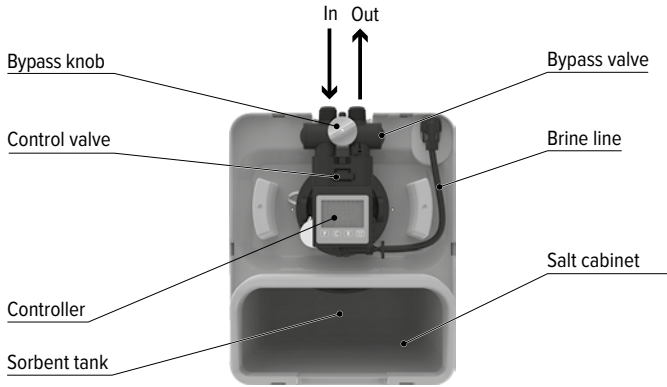
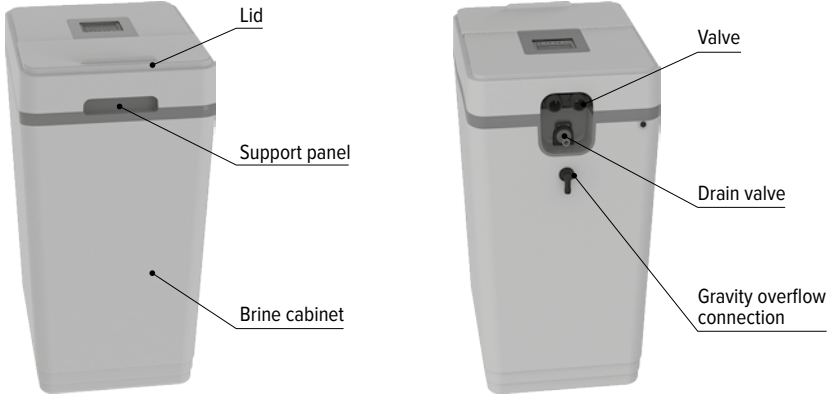

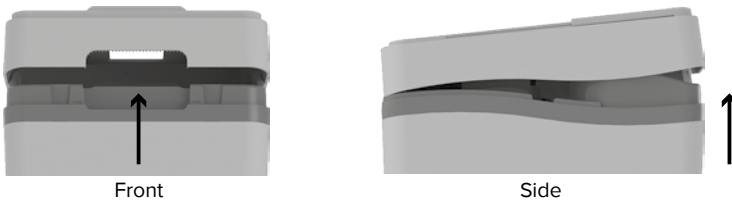

Lid removal

The lid can be removed by grabbing either the front or the rear of the lid and pulling it straight up to access the valve and controller.



Bypass valve

The softener is equipped with a bypass valve (fig. 1). The bypass valve will allow you to turn off the softener in the event of a malfunction or leakage. It also makes it possible to use untreated water for watering plants.

The bypass valve is located in the main control valve assembly. To switch to the bypass line, turn the valve handle to the “Bypass”  position (fig. 1). Water will enter the house past the softener, without treatment. To prevent untreated water from entering the house, do not use the water in the house when the softener is in Bypass mode. Do not forget to switch the softener to normal operation (filtration) by turning the knob to the “Service”  position (fig. 1), after repairing the device or using untreated water.

To obtain water of comfortable hardness, you can use the scheme shown in fig. 5, mixing the source water with purified water.

NOTE: It is not recommended to use source water admixture with high content of iron and/or manganese.

Figure 1

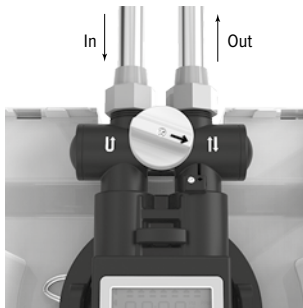
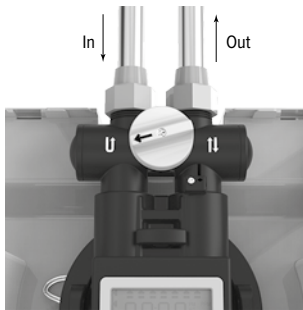

Controller

The controller has four control buttons, LCD display (fig. 2). The controller controls the valve actuators during regeneration. Using the control panel of the controller, the

value of the compensated hardness, the current time, the regeneration time are entered and the parameters of the softener are selected, as well as the status of the device is viewed. For the filter to work correctly, the controller must be configured correctly.

The controller receives data on water consumption from the flow meter. Based on these data and the selected operating parameters, the controller starts the regeneration of the softener at the appointed time.

The controller saves settings in non-volatile memory even after a power outage.

The controller is equipped with a non-volatile power supply that allows for two days to maintain the built-in timer.

Figure 2



Control buttons



User Settings.



Change user settings.



Start regeneration manually. It is used when the softener is connected for the first time or for forced regeneration, for example, if the softener runs out of salt.

Start regeneration manually.

1. Press and hold the button **R** for about 5 seconds.
2. The softener will start regenerating and will display the current stage of regeneration on the display.
3. After all regeneration steps have been completed, the display will return to normal operating mode.

Interruption of a running regeneration cycle (only used for system diagnostics).

4. Press and hold the button **R** for 5 seconds after the regeneration process starts.
5. The display will show the stage number (for example – 01).
6. If the controller does not move to the next stage within 20 seconds, press and hold the button **R** for about 2 seconds, the controller will proceed to the next stage.

*NOTE: Each regeneration step can only be interrupted once it has started. To move to the next stage of the regeneration mode, press **R**.*



Enable / disable the hard hillshade function.

This function can be performed as part of the service in the following cases:

- operation of the softener on water containing dissolved iron,
- with a decrease in the quality of cleaning due to water consumption, significantly exceeding the resource of the softener before regeneration,
- with virtually no regeneration due to insufficient salt, lack of input water or electricity.

In this mode, the softener will be flushed every other day, consuming 2.3 kg salt per regeneration. The softener in the mode of enhanced cleaning from iron should work for at least 2 weeks. The increased frequency of regenerations will help to remove the accumulated iron in the ion exchange resin bed. This service procedure is recommended to be carried out at least once a year.

Controller Screen



The main screen displays the volume of water in liters (or gallons) that will be treated by the softener before the next automatic regeneration. On average, an adult spends 280 l water per day. The volume of water until the next water regeneration is indicated in hundreds or thousands of liters, depending on the value. For example, the number 33 would mean 33 000 l if **x 1000** is shown on the display at the same time, and **3300 l** if this indicator is inactive.

During regeneration, the number of the stage currently in progress will flash on the main screen:

01 – First backwash.

02 – salt regeneration / slow washing.

03 – second backwash

04 – topping up the brine tank.

HO – return to working position. After the regeneration is completed, the display will again show the amount of water until the next regeneration in hundreds of gallons or hundreds / thousands of liters. The duration of regeneration is 30–40 minutes.

Regeneration progress indicator. Indicates that the softener is auto-regenerating or a manual regeneration has started.

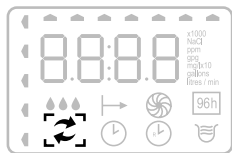

Water consumption indicator. “Droplets” on the display “run” as water flows through the softener. It is convenient for monitoring water consumption and for detecting water leaks.

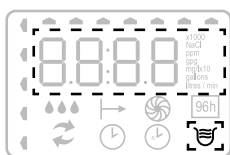
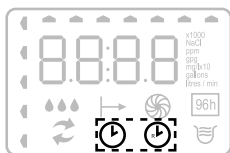

Mode96h. When this mode is enabled, regeneration occurs once every three to four days (72–96 hours) if there is no regular regeneration during this period of time. This is necessary so that the dissolved iron extracted from the water does not precipitate inside the softener. If there is dissolved iron and / or manganese in the source water, the 96h mode must be turned on.

Time of day indicator. Displayed when the system is set to the time of day.

Regeneration time indicator. The dial with the symbol R is displayed if the time of day is set for the regeneration process.

High hillshade indicator from iron is displayed when the function is active.

Installing a softener

The water softener must be connected in accordance with local plumbing regulations.

To connect the softener, it is recommended to contact the Aquaphor service department or Aquaphor regional dealers.

The connection, setup and operation of the device must be carried out within the limits of operation specified in this manual. Failure to comply with the requirements of the passport can reduce the effectiveness of flushing and lead to improper operation of the softener and its failure.

Before installing the softener, check the quality of the water and the parameters of the water supply, power supply and sewerage:

Water quality

Undissolved impurities

If the source water contains sand, sulfur, micro-organisms, algae, oils or other impurities, the water must be pretreated. We recommend installing an Aquaphor pre-filter.

Iron

The concentration of dissolved iron should not exceed 14 mg/l for the S1000 softener, and it is also important to know what form it is in.

- **divalent iron** (often referred to as “dissolved iron”) – The only form of iron that can be removed by the S1000 softener.
- **ferric iron (undissolved iron)** – Precipitation of iron hydroxide. Particles of such iron can clog the ion exchanger layer. Trivalent iron must be filtered before water is supplied to the softener.

- **iron in organic compounds** – a dissolved form of iron associated with organic compounds, usually humic or folic acids. Water containing iron in this form is usually colored brown (“peaty water”). Additional equipment is needed to remove this form of iron.

If the water contains ferrous iron, it is recommended to flush the softener with an ion exchanger cleaner every 6 months. Follow the instructions given in the ion exchanger cleaner data sheet.

Manganese

The manganese content should not exceed 3 mg/l.

ATTENTION! The total content of iron and manganese should not exceed 14 mg/l.

The pH of the water must be greater than 6. If the pH of the source water is less than 6, it is recommended to install a corrective pH filter.

Hardness of water

Model S1000 softens water with hardness up to 34 mg-eq / l (1712 mg/l in terms of CaCO₃).

Water supply parameters

water pressure should be within 0.14 to 0.7 MPa (1.4 – 7 bar). For stable suction of the brine during regeneration, it is recommended to supply water with a pressure of at least 0.2 MPa (2 bar).

Plumbing performance

The minimum required flow for regeneration is 9 l in a minute.

Water temperature not less than +5 and not more than +38 °C.

Sewerage

The unit drain must be routed to a waste water outlet, such as a drain or washing machine drain, in accordance with all local and national plumbing codes. An air gap or siphon must be provided to prevent backflow (see the “Installation and commissioning step by step” section).

Power supply

The power supply is designed for mains voltage of 220 VAC with a frequency of 50 Hz. If there is a possibility of voltage deviation from the specified values by more than 5–10 %, use a voltage stabilizer. This will prevent malfunctions and failure of both the power supply and the electronic components of the softener.

ATTENTION! It is not recommended to separately connect the softener to uninterruptible power supplies, as this may cause failures in the regeneration processes. Connection is only possible in conjunction with a pumping station.

If you have any questions, please contact support. For support information, see the General Information section and the warranty card.

Step-by-step instructions for installing a softener

The softener connection must be made in accordance with local plumbing codes.

The connection, setup and operation of the device must be carried out within the limits of operation specified in this manual. Failure to follow these guidelines may reduce flushing efficiency and result in softener malfunction or failure.

How to do:

- The softener must be installed after the hydraulic accumulator tank and pump control automation systems.
- The softener must be installed in front of the water heater and other appliances that consume water.
- The softener must be installed at least 1m from heating appliances.
- It is not recommended to install the softener on a heated floor, as this may cause excessive evaporation from the brine tank and fouling of the softener surfaces with salt crystals.
- Water for watering a lawn or garden does not require softening and filtration, so this water can be drained before the softener.
- When connecting the softener, it is recommended to provide a bypass valve - “bypass” (see fig. 5). The by-

pass valve will simplify the maintenance of the softener and will provide the supply of unsoftened water in case of emergency when the softener is dismantled. It is also recommended to drain the first portions of contaminated water through the bypass after maintenance work on the well, water supply or pump.

- If the length of the pipe between the softener and the water heater is less than 3m, it is recommended to install a non-return valve on this line as close as possible to the water heater. Make sure the water heater is set to the correct temperature and the safety valve is correct and in good working order.

You cannot do:

- Install and operate the softener in a room where the temperature can drop below +5 °C.
- Install and operate the softener in a room with humidity over 70 %.
- Install the softener near heating appliances.
- Connect the softener to the water supply in the opposite direction.

Step 1. Prepare a place for connection

- Turn off the power and water supply to the water heater. For gas water heaters, additionally turn the gas valve to the “Maintenance” or “Off” position. (See instructions for your water heater).
- Turn off the water supply. Open hot and cold water taps to relieve pressure in the lines. Check the water supply for lime deposits, rust or other contaminants. Clean or replace clogged plumbing.
- Organize the insertion point of the softener, according to fig. 3 so as to prevent axial distortions and tensions during installation, as this can lead to damage to the bypass assembly or softener valve.
- Arrange an electrical outlet at a distance of no more than 2 m.

NOTE: The bore diameter of the pipe from the accumulator tank to the softener must be at least 3/4".

Step 2: Connect the softener to the water supply

The softener must be connected to the water line in accordance with national and local building, plumbing, and electrical codes.

- Remove the softener cover by grabbing either the front or the rear of the cover and pulling it straight up.
- Empty the salt compartment from all packaging and installation materials.
- Make sure that the shims are inserted into the union nuts of the flexible hoses. Connect the softener to the water supply using flexible hoses.

Figure 3

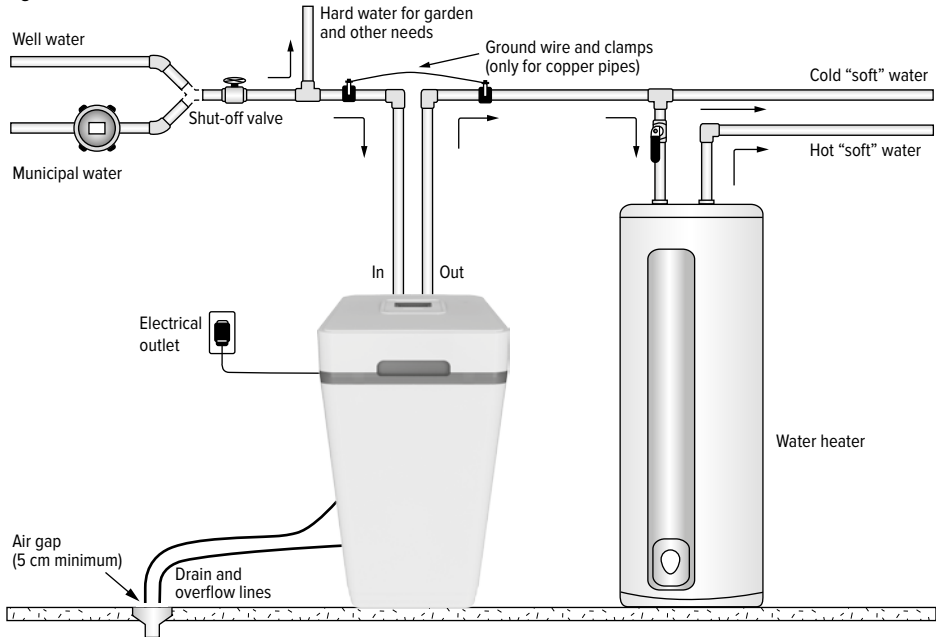

NOTE: Teflon tape or sealant must not be used when connecting with flexible hoses. When connecting with other supply fittings, use only Teflon tape to seal the connections.

- Check that the direction of water flow is correct using the arrow on the bypass valve (see section "Bypass valve").

ATTENTION! Do not connect the softener to the water supply in the opposite direction! This can lead to softener failure.

- Tighten the flexible hose nuts. Do not apply excessive force so as not to damage the threaded part of the fittings.

ATTENTION! To ensure the possibility of dismantling the filter, it is recommended to use a bypass circuit from standard components (fig. 5).

Step 3. Connect the overflow line

- The overflow line is designed to drain excess water when the brine tank is overfilled or the softener depressurizes.
- Screw the elbow overflow fitting included with the softener into the hole on the back of the softener housing and point downwards (see fig. 6).
- Install a flexible tube with an inner diameter 12 mm (1/2") (smaller tubing is not permitted) between an overflow fitting and a drain, washing machine drain,

Figure 4

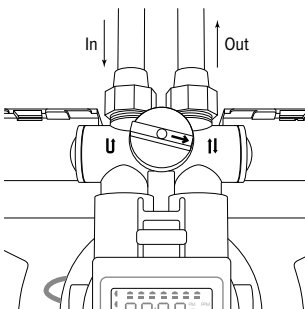

Figure 5

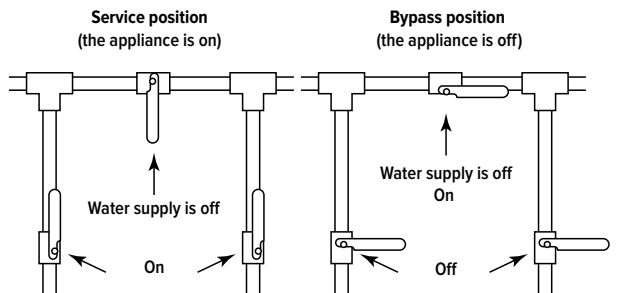
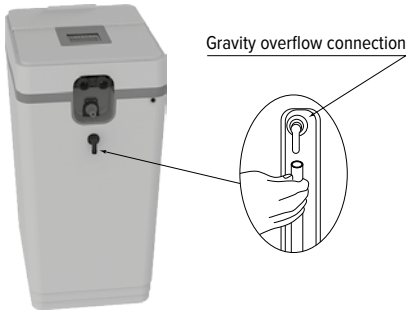

Figure 6



or other suitable waste water outlet. This pipe is not included with the softener.

- Removal of excess water through the overflow line occurs by gravity. Make sure the overflow line terminates at a drain that is at least 8 cm below the edge of the overflow fitting. Provide an air gap of at least 5 cm.
- It is not allowed to bend the outlet tube of the overflow line and lift it in height.

ATTENTION! The overflow line is part of the emergency leak protection system. In its absence, in case of malfunction of the softener and overflow of the brine tank, water leakage is possible.

Step 4 Connect the drain line

The drain line is designed to drain water during regeneration.

- Connect the drain line to the drain port (see fig. 7) using the 5/8" ID (~16mm) flexible hose supplied with the softener. Reducing the diameter is not allowed.
- Run a drain line to a drain, washing machine drain, or other suitable sewage outlet. Provide an air gap of at least 5 cm between the drain line and the maximum fill level of the wastewater receiver in order to prevent backflow.
- The drainage line must be laid in such a way that the distance to the drain is minimal. The drainage line can

Figure 7



be raised to a height of up to 1.5 m above the drain hole of the device, while the pressure in the water supply must be at least 0.275 MPa (2.75 bar).

- The drain line may be extended with a pipe or hose of at least 3/4".
- The drain line must not be kinked, twisted or otherwise damaged to restrict the flow of water.

ATTENTION! It is not allowed to combine drainage (pressure) and overflow (gravity) lines by means of tees, etc.

ATTENTION! During the regeneration process, small solid particles may appear in the drain line, which does not indicate a malfunction of the softener.

Step 5. Flushing the water supply

- Make sure the softener valve is in the "Bypass" position (see fig. 1) Turn on the water supply.
- Open the nearest cold water faucet and flush the pipes of solder flux residue and other foreign material.

NOTE: When the softener is in Bypass mode, the water is not treated.

Step 6. Make sure the connections are tight

Close all outlet taps to pressurize the system.

Check all lines and connections for leaks. If a leak is found:

- a) turn off the water supply;
- b) fix all leaks;
- c) turn on the water supply.

Slowly move the valve to the "Service" position (see fig. 1), slowly, to avoid water hammer, fill the softener.

Open the nearest cold water faucet to bleed air from the system. When water comes out of the faucet without air, close the faucet and check for leaks.

Step 7. Connecting the controller and power supply

NOTE: Make sure the controller is securely attached to the three latches on top of the valve.

Connect to the back of the controller:

- flow sensor connector (fig. 8),
- motor connector,

Figure 8

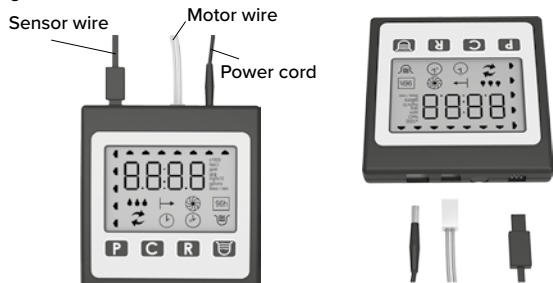

- power supply connector.
 - Lay the power supply wire at the outlet of the water lines. Connect the power supply to an outlet.
 - Make sure the outlet to which the softener is connected does not have an ON/OFF switch.

Step 8. Adjust the softener controller according to the Controller Setup section.

Step 9. Rinse the softener

- Pour 8 l of water into the brine tank.
- Make sure the softener is in filtration mode and the water supply is turned on.
- Perform a forced regeneration. To do this, press and hold the **R** button for about 5 seconds until the numbers **01** appear on the display and the regeneration process starts.
- During the regeneration, which lasts 30–40 minutes, the device will first take and then add water to the brine tank to the desired level.

ATTENTION! The brine tank should only be filled with water when the softener is started. After starting, topping up water is carried out automatically.

Step 10. Load Salt into the Brine Tank

Load salt into the brine tank up to 25 kg. Use refined table salt or granulated table salt (NaCl). Do not use these two types of salt at the same time. Use only high-quality tableted or granulated salt, such as AQUAPHOR. Poor quality salt can cause a decrease in the efficiency of regeneration or the failure of the softener.

NOTE: Always keep the salt level above the water level. For convenience, when adding salt, fully load the tank. After adding salt, including adding after salt is completely used up, wait at least two hours before starting regeneration. This is necessary for the formation of a saturated saline solution.

Step 11. Complete the installation process

Make sure the bypass valve is in the “Service” position (see fig. 1).

Make sure the water supply is turned on.

If there is an external bypass circuit, make sure the taps are in the correct position (see fig. 5).

Turn on the power and water supply to the water heater (if any). For gas water heaters, turn the gas valve to the “Operation” position (see the instructions for your water heater).

Open the nearest cold water faucet and run the softener for 20 minutes or until about 270 liters water.

Make sure that the water consumption indicator on the controller display is working – this indicates the water consumption and the operation of the liter counter.

Replace the softener cover.

Controller setup

For the correct operation of the softener, it is necessary to enter into the processor data on the content of hardness salts, iron and manganese in the water.

To do this, it is necessary to calculate the total parameter, which will include all these pollutants. This parameter is called “compensated stiffness”.

Generally, in water analysis, total hardness is expressed in mg-eq / l.

ATTENTION! German (DH) and French (°F) are differ from mg-eq / l.

To calculate the “compensated stiffness” it is necessary:

- Multiply the number of mg-eq / l by 50.
- Add the concentrations of iron (mg/l) and manganese (mg/l) and multiply the sum by 85.
- Add up both items.

EXAMPLE:

Total hardness = 6.84 mg-eq / l

Ferrous iron (dissolved) = 3 mg/l

Manganese = 1 mg/l

Compensated stiffness = $6.84 \times 50 + (3+1) \times 85 = 682$

Note. If the total hardness is presented in the analysis as a concentration of CaCO₃ (mg/l), it is not necessary to multiply the value by 50.

EXAMPLE:

General hardness = 342 mg/l CaCO₃

Ferrous iron (dissolved) = 3 mg/l

Manganese = 1 mg/l

Compensated stiffness = $342 + (3+1) \times 85 = 682$

If you have any questions, please contact Aquaphor support.

Quick Setup / Basic Settings

Step 1. Set the hardness value

- Click **P**. After approximately 4 seconds, the controller will beep and the display will show ppm
- Press **C** until the number on the display corresponds to the required hardness to be compensated (see section “Checking before installation”).
- Click **P** to save the settings and proceed to the next step.

Step 2. Setting the current time

- Press **C** until you set the current hour. Press **P** to save the setting and move on to setting the minutes.
- Press **C** until you set the current minutes. Press **P** to save the setting and go to the home screen.

NOTE: The current time is shown in 24 hour format.

Mode of enhanced washing from iron





Step 1. Turning on / off the enhanced iron cleaning mode

Press and hold  to turn the feature on or off. In the mode of enhanced cleaning from iron, a more intensive washing of the softener with saline occurs, which contributes to more efficient cleaning of the sorbent from iron. When this mode is enabled, regeneration occurs every other day. To achieve the desired effect, the mode of enhanced iron washing should be switched on for at least 2 weeks. Depending on the iron content of the water, it is recommended to carry out this procedure at least once a year.

Advanced settings

Advanced settings allow you to select the brine regeneration mode, turn on the 96h mode, change the liter/gallon and mg/L/gpg units, and set the regeneration start time. Please be careful when using advanced settings.

Salt regeneration mode change

- A. Press and hold  and  for about 4 seconds, the controller will beep and display the brine regeneration mode on the display.
- B. Press  to cycle through AU, HC, and HE modes. Press  to save the selected option and proceed to step 2.

Salt regeneration modes:



AU (Auto mode) – in this mode, the controller monitors the daily water consumption and regulates the amount of salt for regeneration. If the **96h** mode is disabled, the controller will regenerate 2 times a week if there is water demand.

HC (High capacity mode) – fixed setting of salt regeneration, which allows less frequent washing of the sorbent.

HE (High economy mode) – fixed salt regeneration setting, which reduces the amount of water to be treated between flushes, but significantly saves salt.

Enabling / Disabling the forced regeneration mode “72-96 hours”

In this mode, the controller will regenerate automatically, at the appointed time once every 3–4 days, if normal regeneration did not occur during this interval.

Press  to turn **96h** mode on or off. The display on the right side will show or turn off the indicator **96h**. Click  to save your settings and move on to the next step.





96h mode. Activation of the **96h** mode ensures that the regeneration process is carried out at least 2 times a week. This mode must be switched on if there is iron and/or manganese in the source water.

NOTE: More frequent regenerations help the softener to recover more effectively from iron.

Unit switching: gallon / liter

Press **C** to switch gallon/liter units. The changes will be displayed on the screen as **gallons** or **liters**. Click  to save your settings and move on to the next step.

Setting the regeneration start time

- A. Press  to set/change regeneration start time (hours). Press  to save the settings and go to the minutes setting.
- B. Press  to change the minutes at which regeneration starts. Click  to save the settings and go to the home screen.

NOTE: Time is shown in 24 hour format.

Recommendations for effective use softener

To get the most out of your softener, follow these guidelines:

- Add salt if the level is below the water level in the brine tank. The salt level must always be at least 1/3 of the full load.
- It is recommended to use pure salt in tablets or granules. Don't use rock salt.
- Once every 6 months it is recommended to use an ion exchanger cleaner.

ATTENTION! Do not mix different types of salt.

- In the event of a power outage, check the correctness of the controller settings (type of regeneration, water parameters, time); if necessary, set the correct values. (See the Controller Setup section).
- Program the softener to regenerate at times of the day when you don't normally use water. If you have several water treatment devices that require regeneration, the time between device regenerations should be at least two hours.
- Please note that other water-using devices, such as washing machines and dishwashers, should not be running while the softener is regenerating.
- Protect the softener from freezing, including the drain line.
- Follow the requirements for operation, maintenance and placement of the softener.
- If the softener runs out of salt during operation: add salt; wait at least two hours for the salt to dissolve and then start the regeneration. To do this, press and hold the **R** button for 5 seconds; regeneration will be completed in approximately 30–40 minutes, after which the softener will return to normal operation.

- If the incoming water contains sediment, sand or other undissolved particles, a pre-filter should be used. For example, pre-filter Aquaphor Gross or Gross Midi.
- The device can be disinfected with 5.25% sodium hypochlorite solution, which is the active ingredient in household bleach. To disinfect the device, pour 120 ml of bleach solution or 25 ml of concentrated sodium hypochlorite solution into the brine tank's brine shaft. There must be water in the brine tank. Start regeneration manually.
- Use the bypass to flush the plumbing after repair or maintenance.
- Check and clean the brine tank and air release valve annually or when sediment appears in the tank.

Safety regulations

- During operation, observe the general electrical safety rules when using electrical appliances.
- It is forbidden to repair the softener by persons who do not have special training.
- Before connecting, check that the mains voltage matches the operating voltage of the softener's power supply.
- It is forbidden to use homemade adapters and extension cords. Protect the electrical cord from damage.

Precautions when connecting your Softener to the mains

Check that the main voltage matches the parameters specified in this Manual before connecting your Softener to the mains. Only use a power supply unit with output characteristics specified in this Manual.

Make sure that your Softener is protected from freezing, water, direct sunlight, contact with hot objects, including hot water, heating pipes and heating devices before installing. Keep your Softener from hitting and falling.

The power cord must not be tensioned when your Softener is connected. Make sure that the power cord does not touch surfaces that could damage it.

Do not immerse the Softener, as well as the AC adapter, power cord, and power cord plug, in water or other liquid, and do not wash them under running water or in a dishwasher.

To avoid electric shock, do not touch your Softener connected to power with wet hands, as well as the power supply unit, the power cord and the plug.

Keep your Softener housing clean. Disconnect your Softener from the power supply and wipe, if necessary, with a dry cloth.

Do not disassemble your Softener nor open its housing!

Do not use the Softener and the power supply in case of malfunction or damage to the cord. Do not repair the device

yourself. First disconnect the power supply from the mains, then disconnect it from the Softener if any malfunction is detected. It is recommended to contact your service provide.

Rules for storage and transportation

- The softener is stored in a polyethylene package, in a closed cardboard container, in enclosed spaces with natural ventilation, at a relative humidity of not more than 80%, at a temperature not lower than +5 °C and not higher than +38 °C. The shelf life before the start of operation is no more than 2 years.
- The softener is transported and stored in an upright position. It is forbidden to tilt the softener, subject it to shocks and other mechanical influences.
- The softener is transported packed by any type of covered transport in a fixed state.

Disposal

Disposal in accordance with environmental, sanitary and other requirements established by national standards in the field of environmental protection and ensuring the sanitary and epidemiological welfare of the population.

Terms of Service and Warranties

Aquaphor water Softener – Two Year Warranty from the date of purchase under normal use and service. This does not apply, however, to filter material and/or ion exchange resin.

Exclusions and Limitations

- Aquaphor warrants its products to be free from manufacturing defects under normal use and service. This warranty is extended only to the ORIGINAL PURCHASER.
- Aquaphor obligations under this warranty are limited to repairs or replacement, at Aquaphor's option, of products or parts found to be defective, provided that such products were properly installed and used in accordance with instructions. Aquaphor reserves the right to make such inspections as may be necessary in order to determine the cause of the defect. Aquaphor will not charge for labor or parts in connection with warranty repairs for the first full year from date of purchase on all products except those that may be subject to commercial use limitations.
- Aquaphor is not responsible for the cost of removal, return (shipping) and/or reinstallation of products.

This warranty does NOT apply to:

Damage or loss which occurs during shipment.

Damage or loss sustained through any natural or man-made causes beyond the control of Aquaphor, including but not limited to fire, earthquake, floods, etc.

Damage or loss resulting from sediments or foreign matter contained in a water system.

Damage or loss resulting from negligent or improper installation including installation of a unit in a harsh or hazardous environment.

Damage or loss resulting from removal, improper repair, modification of the product, or improper maintenance including damage caused by chlorine or chlorine related products.

Damage or loss resulting from acts which are not the fault of Aquaphor or which the Product is not specified to tolerate.

This warranty gives you specific legal rights. You may have other rights which may vary from state. to state

THIS WRITTEN WARRANTY IS THE ONLY WARRANTY MADE BY AQUAPHOR. REPAIR OR REPLACEMENT AS PROVIDED UNDER THIS WARRANTY SHALL BE THE EXCLUSIVE REMEDY AVAILABLE TO THE PURCHASER.

AQUAPHOR SHALL NOT BE RESPONSIBLE FOR LOSS OF USE OF THE PRODUCT OR FOR OTHER INCIDENTAL, SPECIAL, FOR CONSEQUENTIAL DAMAGES OR EXPENSES

INCURRED BY THE PURCHASER OR FOR LABOR OR OTHER COSTS DUE TO INSTALLATION OR REMOVAL OR COSTS OF REPAIRS BY OTHERS, OR FOR ANY OTHER EXPENSE NOT SPECIFICALLY STATED ABOVE. EXCEPT TO THE EXTENT PROHIBITED BY APPLICABLE.

LAW, ANY IMPLIED WARRANTIES, INCLUDING THAT OF MERCHANTABILITY, ARE EXPRESSLY LIMITED TO THE DURATION OF THIS WARRANTY. SOME STATES DO NOT ALLOW LIMITATIONS, SO THE ABOVE LIMITATION AND EXCLUSION MAY NOT APPLY TO YOU.

Any defects covered by this warranty should be promptly reported to the AQUAPHOR: AQUAPHOR INTERNATIONAL OÜ, L. Tolstoy 2A, Sillamäe, Estonia, 40231.

www.aquaphor.com

The service life of the softener (excluding filter material and/or ion exchange resin) is not more than 5 years from the date of sale (determined by the shop stamp in this manual).

The softener shelf life is 2 years before operation when stored at + 5 to + 40 °C, without breach of packaging.

If you have any issue with the operation of your Softener, please, contact the seller or the manufacturer.

For further information on parts and service please contact EU customer service department at: +372 39 24 116; +48 22 870 24 32 sales@aquaphor.com,

www.aquaphor.com

Troubleshooting

| Probable Cause | Solution |
|--|---|
| Problem: | No soft water output after softener regeneration |
| There is no salt in the brine tank | Sprinkle salt |
| Solids in the brine tank clogged the brine line, brine valve, air check valve or injector | Dismantle the brine line together with the air cut-off valve Air check. Rinse them with clean water. Clean brine valve and injector. Remove impurities from the salt tank |
| Clogged or improperly installed brine line flow restrictor | Dismantle the brine valve, clean and properly install the restrictor salt flow |
| Drain line kinked, frozen, or clogged | Straighten the line, let it thaw or clean it |
| Clogged injector | Remove the injector cap, clean the nozzle with a wooden toothpick. Reinstall the removed items. |
| A salt bridge has formed (appearance of salt) in the salt compartment due to high humidity or the use of the wrong type of salt | Try to break the crust with a blunt object, you can use hot water. Add salt if there was none. Use only high quality granular or tablet salt. |
| Problem: | No soft water at softener outlet |
| Bypass valve is in Bypass position or deviated from Service position | Set bypass valve to normal operation. Service |
| The device is connected to the water supply in the opposite direction | Check if the device is connected correctly |
| Prolonged power failure | Reset the current time |
| Lack of accounting for water consumption | See if the water consumption indicator on the softener works when the water is being drawn. If not, see below. |
| The composition of the source water has changed | Explore the water, make changes to the settings according to the new data |
| Raw water is mixed with purified | Make sure that there is no mixing of raw water |
| Problem: | Sensor registers water flow when water is not flowing |
| Water leak after softener | Fix the leak |
| Problem: | No indication on the display |
| Power wire not connected | Connect the power supply |
| No mains power | Check for power at the outlet. |
| Faulty power supply | Check the power supply with a voltmeter. Should be 12 VAC. If the voltage is less than 10 VAC, check the voltage at the 220 VAC outlet |
| Faulty controller | If 12 VAC is being supplied to the controller, replace the controller |
| High ambient temperature. At air temperature +38°C or higher, the display will not show characters. The functionality of the controller is preserved | No option but to lower the temperature |
| Problem: | The device does not exit the regeneration mode |
| Controller incorrectly installed | Make sure the controller is fixed on the screw mechanism cover correctly |
| Defective magnetic arm | Replace magnetic arm |
| Foreign object in control valve mechanism | Disassemble valve, remove foreign object |
| The control valve is out of order, the engine is running | Repair or replace control valve |

| Probable Cause | Solution |
|---|---|
| Problem: Excess water in brine tank | |
| Drain line clogged, kinked, or frozen | Remove the blockage, straighten the kink in the drain line |
| Clogged brine line, brine line flow restrictor or Air check valve | Clean the brine line, brine line flow restrictor and air check valve. Remove dirt from the salt tank |
| Clogged injector | Clean or replace injector. If the injector neck has been removed, replace it with a new one. |
| Problem: Regeneration sequence broken | |
| Damaged magnetic lever | Replace magnetic arm |
| Faulty controller | Replace controller |
| Problem: Salt water outlet | |
| Damaged injector | Replace injector including neck |
| Low inlet water pressure | Minimum working pressure 0.14 MPa |
| Drain restrictor clogged | Remove blockage |
| Salt line clogged or damaged | Remove blockage, replace line if damaged |
| Too much water in brine tank | Check that the water level in the tank* and the brine regeneration settings are correct. Check brine, drain lines and tightness of valve assemblies |
| Unstable pressure of the supplied water, the formation of a vacuum at the inlet | Install a check valve before softener. Stabilize the inlet pressure |
| Brine valve leak | Clean brine valve, replace brine valve seals |
| Problem: Ошибки контроллера | |
| E1 - Home position not detected | Turn the power off and on by unplugging and plugging in the AC adapter. The search for the home position will start again. Make sure the controller is fully and securely attached to the screw mechanism cover |
| E2 - Engine malfunction | Disable email. power and connect the motor. If it was already connected, replace the motor. Make sure the power supply is 12V AC |
| E3 - Shift Home | The magnetic arm does not start from the correct home position. The controller will automatically attempt to adjust by searching for the home position and continue regeneration. Make sure the controller and magnetic arm are fully and securely attached. |
| E4 - Home position locked | Transmission teeth not engaged or stripped. Something has jammed the valve mechanism. Clear the jam, then power cycle the softener to clear the error. |
| E5 - Memory error | To clear the error, turn the power off and on. If error persists, replace controller. |

* The water level must not reach the level of the float and the overflow fitting.

Warranty coupon Aquaphor Softener

| | |
|-------------------------|--|
| Aquaphor Softener Model | |
| Serial # | |
| Date of Sell | |
| Seller's stamp | |
| Seller's signature | |

Installation information

| | |
|---|--|
| Name of the company which carried out installation: | |
| Name of the service engineer: | |
| Service engineer's signature: | |
| Client's signature: | |
| For installation, operational and technical maintenance, please, contact: | |

For further information on parts and service please contact EU customer service department at + 372 600 2255; + 48 22 250 2333 sales@aquaphor.com, www.aquaphor.com



The Quality Management System
is certified according to ISO 9001.

The manufacturer reserves the right to make improvements to the design of the Aquaphor water softener without being mentioned in this Manual.

Manufacturer: AQUAPHOR INTERNATIONAL OÜ, L. Tolstoi 2A, Sillamäe, Estonia, 40231. www.aquaphor.com

AQUAPHOR®

Aquaphor water softener models:

1

S1000

2

S1000 P1

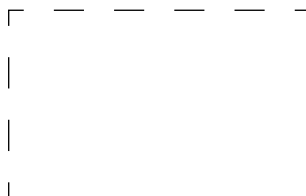

The number of the Aquaphor water softener model, the manufacturing and quality control date, as well as the product's serial number are indicated on a special sticker on this page.